

Top Silk

Complete PCB

Circuit as seen from PCB bottom

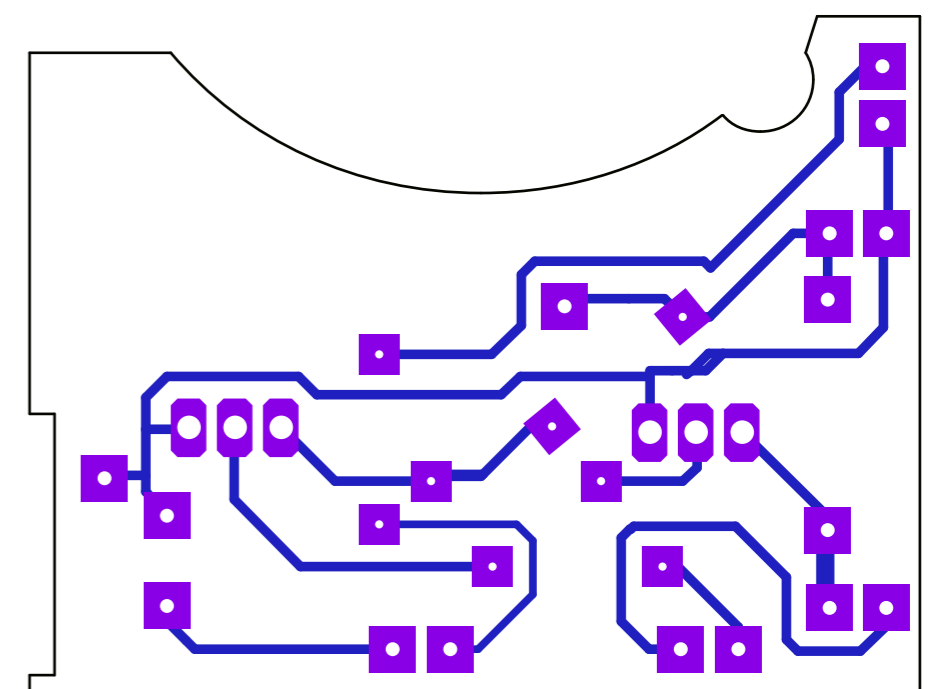
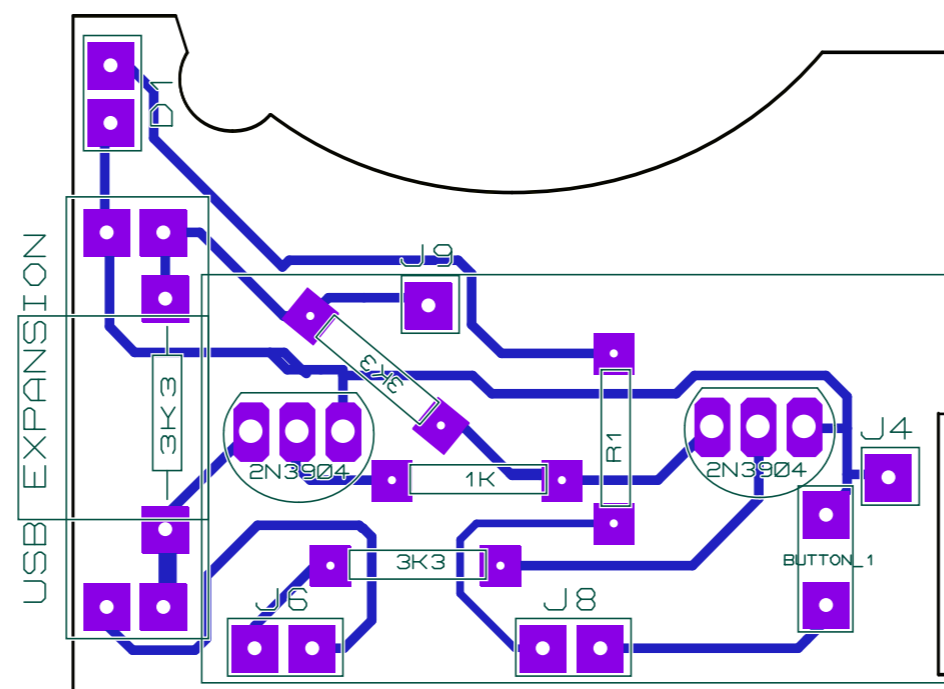
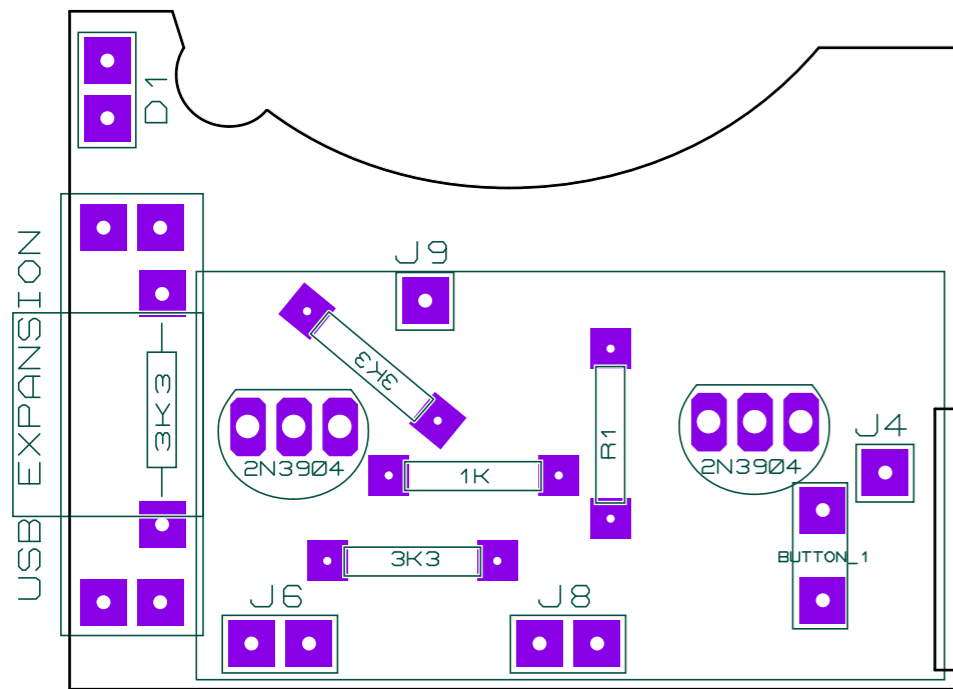

Drawing Scale: 3x

